

belsh

*LOTIS BHD110*

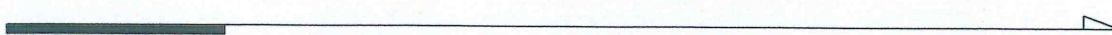

**MONTAGE HANDLEIDING**  
***MANUEL DE POSE***



## Algemene informatie

Controleer de producten bij ontvangst onmiddellijk op eventuele schade, ontbrekende delen of productiefouten. Problemen dienen onmiddellijk gemeld te worden, latere meldingen zijn niet ontvankelijk en zullen geweigerd worden.

Behandel de producten met zorg, vermijd tijdens transport of plaatsing stoten of schokken van het glas in het bijzonder van de hoeken.

## Opmerking: safety-glass kan niet her-bewerkt worden.

Lees deze instructie grondig vooraleer te starten met de installatie. Speciale aandacht dient genomen te worden bij het boren voor verborgen leidingen (water, gas, elektriciteit, ...)

Deze producten zijn zwaar en vereisen 2 personen voor de installatie.

Laat na installatie de siliconen drogen gedurende 24 uren.

## Onderhoud na installatie

Na gebruik dient de douche gekuist te worden met water en zeep. Dit is vooral noodzakelijk in gebieden met een hoog kalkgehalte in het water. Wees voorzichtig met het gebruik van chemicaliën.

## Information général

Vérifiez les produits dès réception pour dégâts, manquants ou erreurs de production éventuelles. Des problèmes doivent être rapporté immédiatement, des complaints après ne seront plus acceptés et seront refusés.

Traitez les produits avec grand soin. Evitez des coups et des chocs pendant le transport ou l'installation, surtout pour les coins.

## Remarque: il est impossible de faire des corrections ou adaptations sur safety-glass.

Lisez cette instruction avec attention avant de commencer l'installation, et faites-bien attention pendant le forage à des tubes de gaz, électricité, l'eau, ... caché dans le mur.

Les produits sont assez lourds, l'installation est avisé à faire par 2 personnes.

N'utilisez pas la douche pendant 24 heures après installation pour le séchage des silicones.

## Maintenance et entretien après usage.

Après usage, la douche doit être nettoyée à l'eau et le savon. Cela est avisé particulièrement dans des régions avec beaucoup de la chaux dans l'eau. Soignez prudent avec des produits chimiques.

## Nodige gereedschap Outils nécessaires

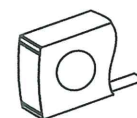
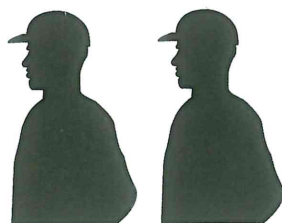
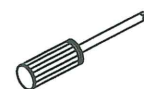
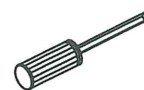
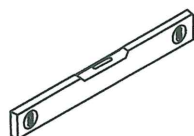
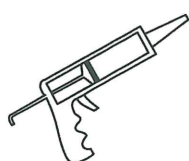



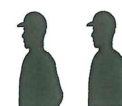





Deze producten zijn zwaar en vereisen 2 personen voor de installatie.  
Les produits sont assez lourds, l'installation est avisé à faire par 2 personnes.

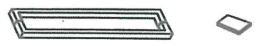

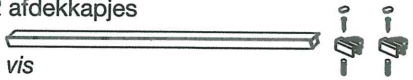
# PACKING LIST

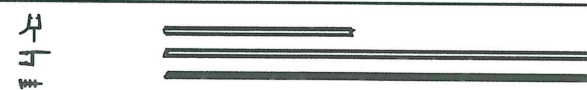
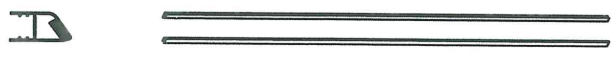
- INHOUD TE CONTROLEREN VOOR INSTALLATIE
- A VERIFIER AVANT INSTALLATION

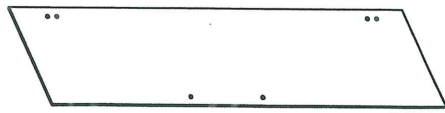
[1]	2 scharnieren + 4 schroeven M5x35 + 4 pluggen + 4 afdekkapjes 2 charnières + 4 vis M5x35 + 4 chevilles + 4 caches vis	➔	
[2]	1 installatie-instructie 1 manuel de pose	➔	
[3]	1 set deurgrepen + 1 afdekking profiel 1 set poignées + 1 couverture profil	➔	
[4]	4 pluggen + 4 schroeven M4x35 4 chevilles + 4 vis M4x35	➔	
[5]	1 aluminium element + 2 clips + 2 schroeven Mx35 + 2 afdekkapjes 1 élément aluminium + 2 clips + 2 vis Mx35 + 2 caches vis	➔	
[6]	1 stang + 1 connectiestuk + 2 clips + 2 muurhechtingen 1 barre + 1 connecteur + 2 clips + 2 fixations au mur	➔	
[7]	3 geleiders 3 conducteurs	➔	
[8]	2 magnetische elementen 2 éléments magnétiques	➔	
[9]	1 profiel 1 profil	➔	
[10]	1 vast paneel 1 panneau fixe	➔	
[11]	1 deurpaneel 1 panneau de porte	➔	

# INSTRUCTIES VOOR INSTALLATIE

## MANUEL DE POSE

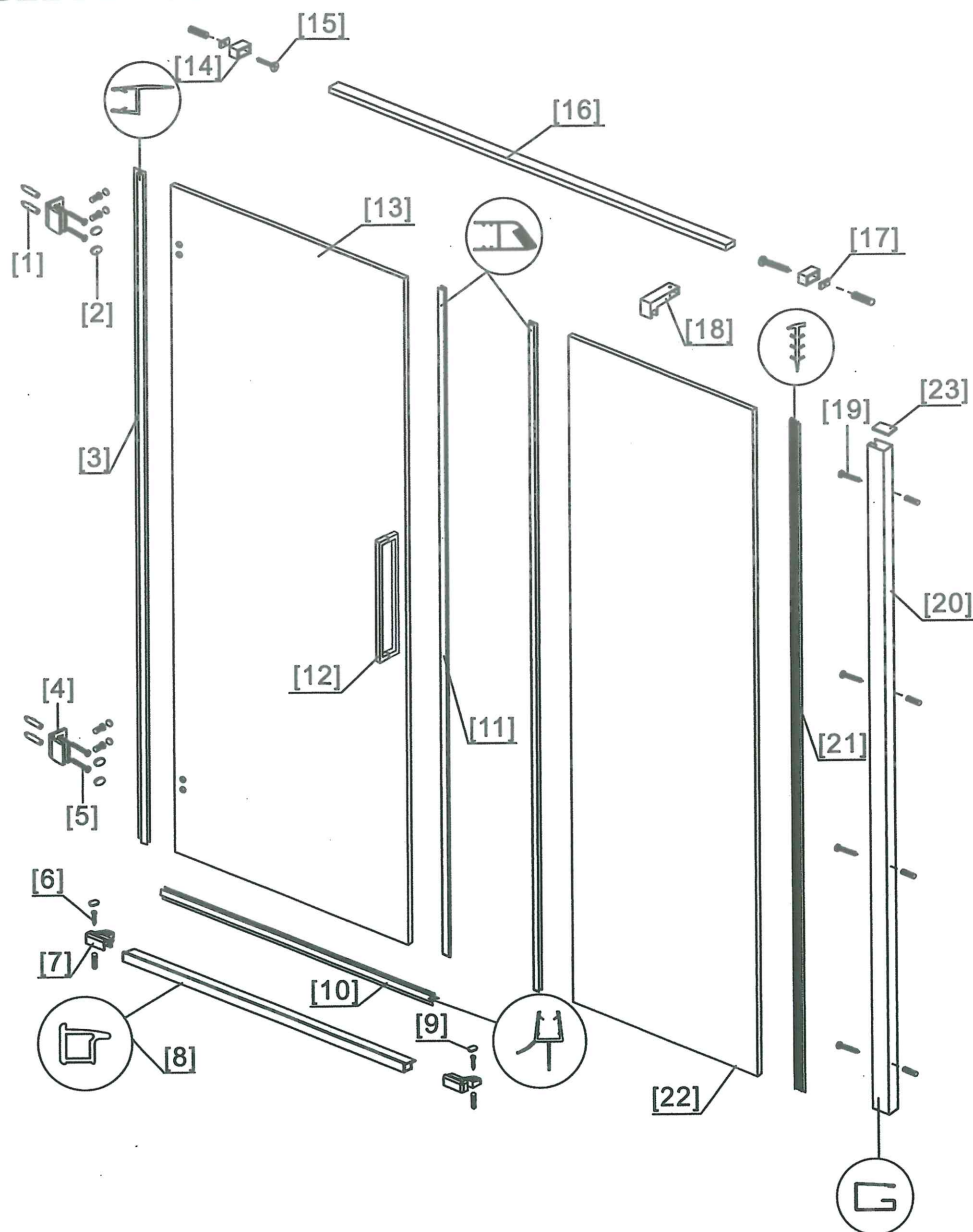

- |                                 |                              |
|---------------------------------|------------------------------|
| [1] 12 pluggen                  | [1] 12 chevilles             |
| [2] 4 afdekkapjes schroeven     | [2] 4 caches vis             |
| [3] 1 geleider                  | [3] 1 conducteur             |
| [4] 2 scharnieren               | [4] 2 chevilles              |
| [5] 2 schroeven M5x35           | [5] 2 vis M5x35              |
| [6] 2 schroeven M4x25           | [6] 2 vis M4x25              |
| [7] 2 clipsen                   | [7] 2 clips                  |
| [8] 1 aluminium element         | [8] 1 élément aluminium      |
| [9] 2 afdekkapjes schroeven     | [9] 2 caches vis             |
| [10] 1 geleider                 | [10] 1 conducteur            |
| [11] 2 magnetische elementen    | [11] 2 éléments magnétiques  |
| [12] 1 set deurgrepen           | [12] 1 set poignées          |
| [13] 1 deurpaneel               | [13] 1 panneau de porte      |
| [14] 2 muurhechtingen           | [14] 2 connections au mur    |
| [15] 2 schroeven M4x35          | [15] 2 vis M4x35             |
| [16] 1 stang                    | [16] 1 barre                 |
| [17] 2 hechtingen               | [17] 2 connections           |
| [18] 1 hechtingsstuk voor stang | [18] 1 connection pour barre |
| [19] 4 schroeven M4x35          | [19] 4 vis M4x35             |
| [20] 1 profiel                  | [20] 1 profil                |
| [21] 1 geleider                 | [21] 1 conducteur            |
| [22] 1 vast paneel              | [22] 1 panneau fixe          |
| [23] 1 afdekplaat profiel       | [23] 1 couverture profil     |

# ◆ Installation Steps

## Step 1

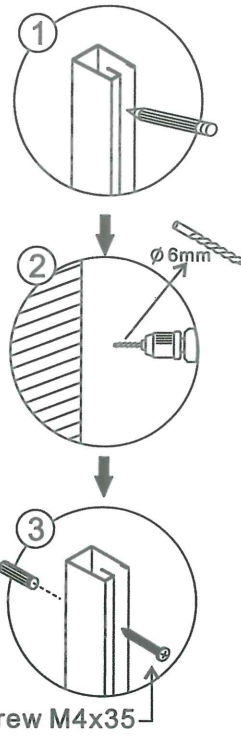
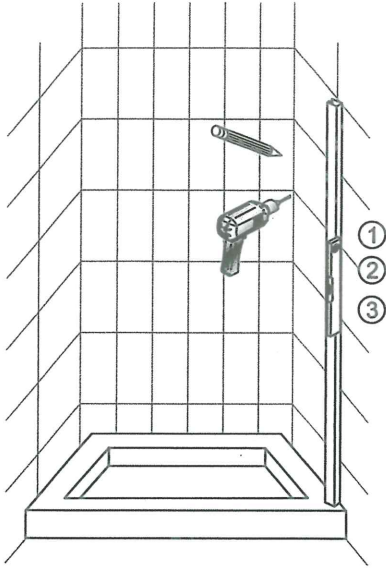

## Step 2

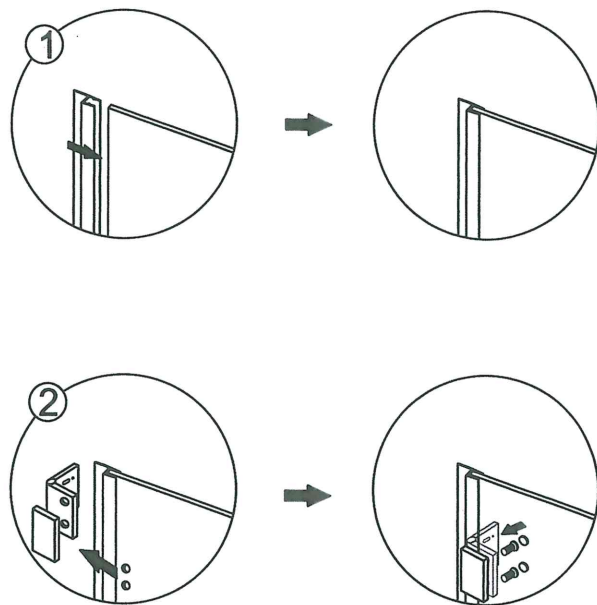
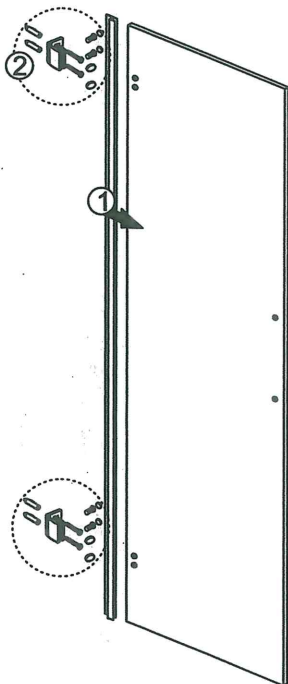

### Step 3

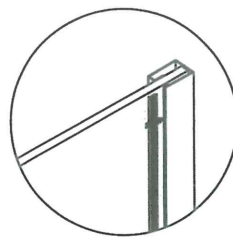
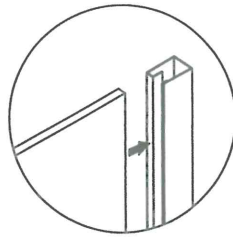
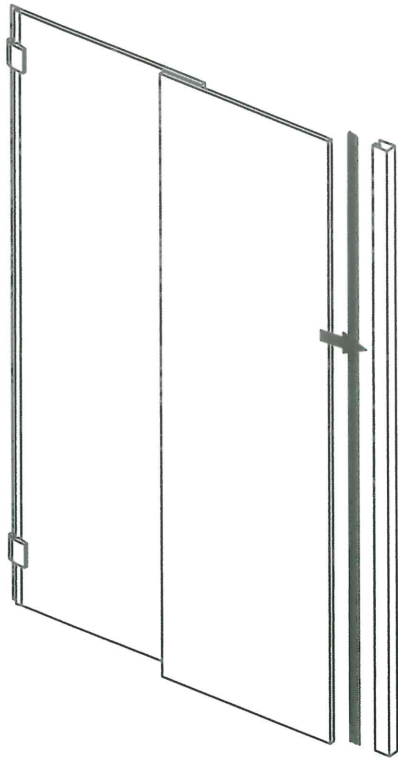

View from inside

### Step 4

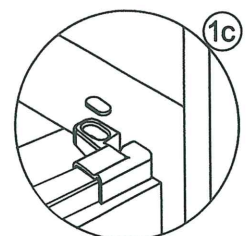
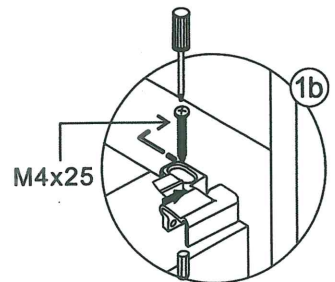
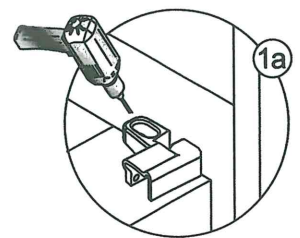
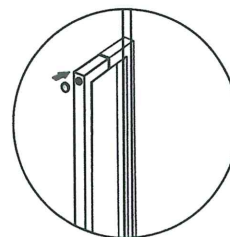
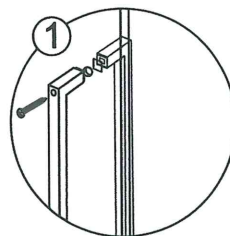
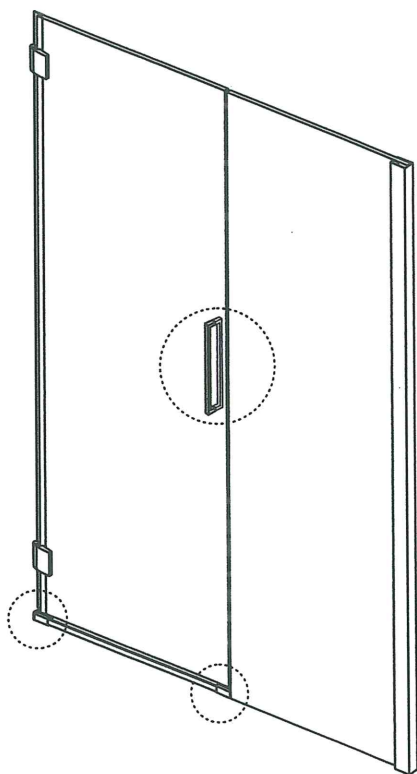

## Step 5

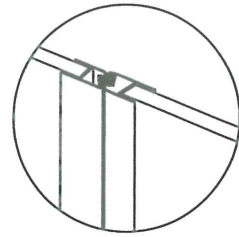
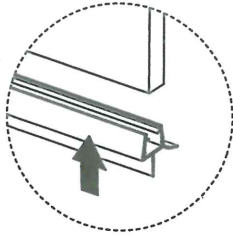
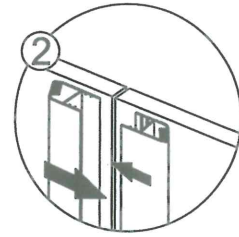
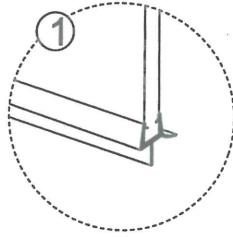
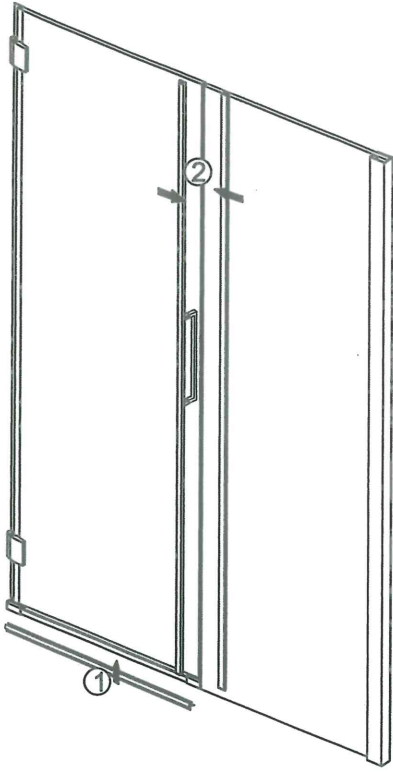

## Step 6

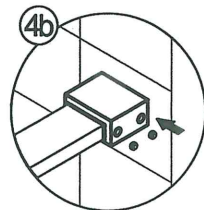
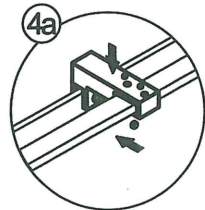
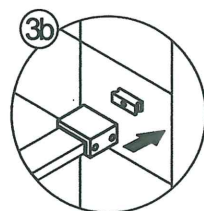
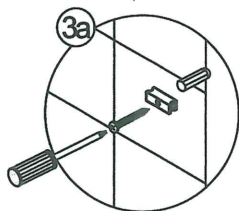
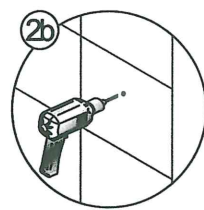
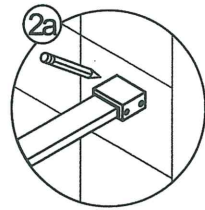
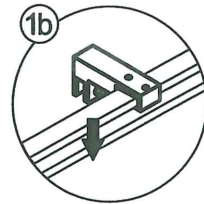
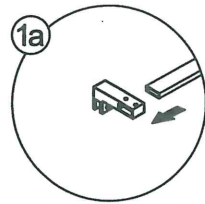
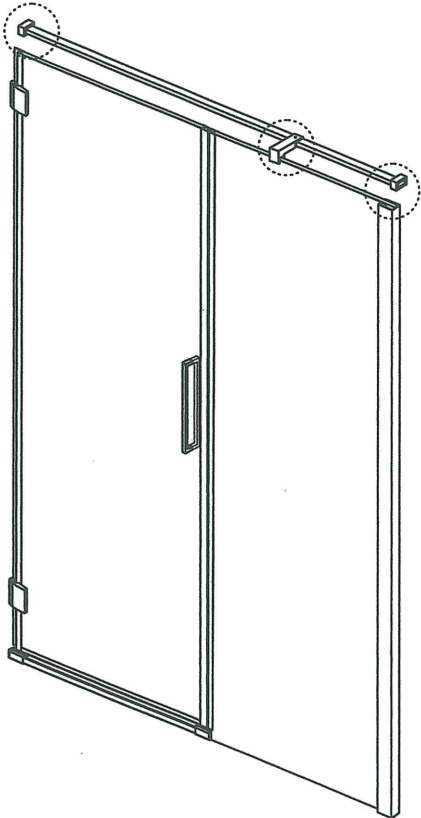

## Step 7

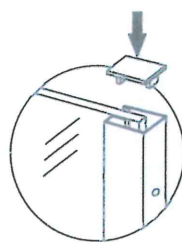
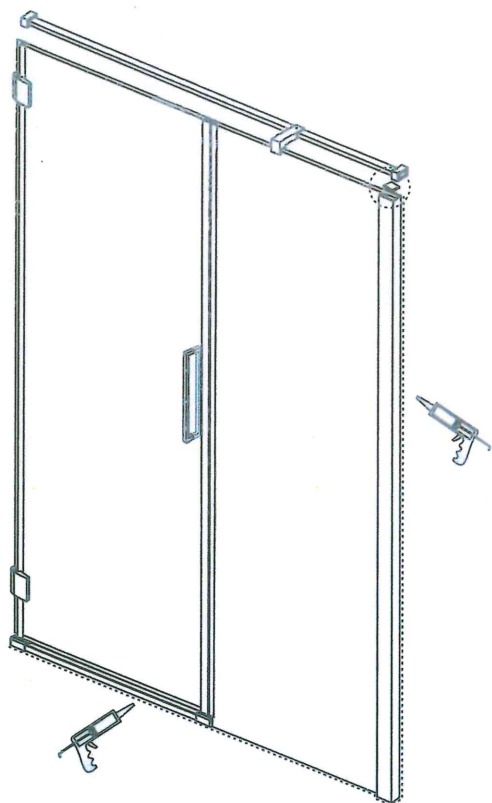

Allow 24 hours for silicone to dry before use.

<b>DEUR PORTE</b>	<b>Breedte - Largeur</b>	<b>Hoogte - Hauteur</b>
BHD110	966 > 980	2000
BHD112	1166 > 1180	2000
BHD114	1366 > 1380	2000
BHD116	1466 > 1580	2000

belsh



[www.belsh.be](http://www.belsh.be)