

belsh

LOTIS BHD108

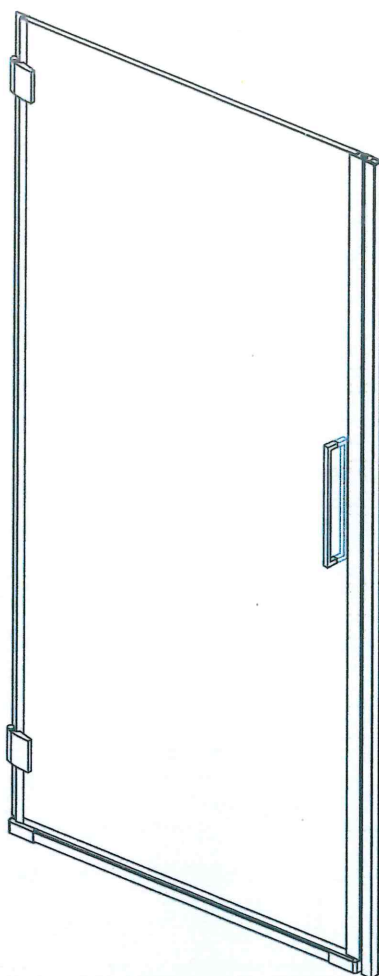

MONTAGE HANDLEIDING
MANUEL DE POSE



Algemene informatie

Controleer de producten bij ontvangst onmiddellijk op eventuele schade, ontbrekende delen of productiefouten. Problemen dienen onmiddellijk gemeld te worden, latere meldingen zijn niet ontvankelijk en zullen geweigerd worden. Behandel de producten met zorg, vermijd tijdens transport of plaatsing stoten of schokken van het glas in het bijzonder van de hoeken.

Opmerking: safety-glass kan niet her-bewerkt worden.

Lees deze instructie grondig vooraleer te starten met de installatie. Speciale aandacht dient genomen te worden bij het boren voor verborgen leidingen (water, gas, elektriciteit, ...)
Deze producten zijn zwaar en vereisen 2 personen voor de installatie.
Laat na installatie de siliconen drogen gedurende 24 uren.

Onderhoud na installatie

Na gebruik dient de douche gekuist te worden met water en zeep. Dit is vooral noodzakelijk in gebieden met een hoog kalkgehalte in het water. Wees voorzichtig met het gebruik van chemicaliën.

Information général

Vérifiez les produits dès réception pour dégâts, manquants ou erreurs de production éventuelles. Des problèmes doivent être rapportés immédiatement, des plaintes après ne seront plus acceptés et seront refusés.
Traitez les produits avec grand soin. Évitez des coups et des chocs pendant le transport ou l'installation, surtout pour les coins.

Remarque: il est impossible de faire des corrections ou adaptations sur safety-glass.

Lisez cette instruction avec attention avant de commencer l'installation, et faites-bien attention pendant le forage à des tubes de gaz, électricité, l'eau, ... caché dans le mur.
Les produits sont assez lourds, l'installation est avisé à faire par 2 personnes.
N'utilisez pas la douche pendant 24 heures après installation pour le séchage des silicones.

Maintenance et entretien après usage.

Après usage, la douche doit être nettoyée à l'eau et le savon. Cela est avisé particulièrement dans des régions avec beaucoup de la chaux dans l'eau. Soignez prudent avec des produits chimiques.

Nodige gereedschap Outils nécessaires

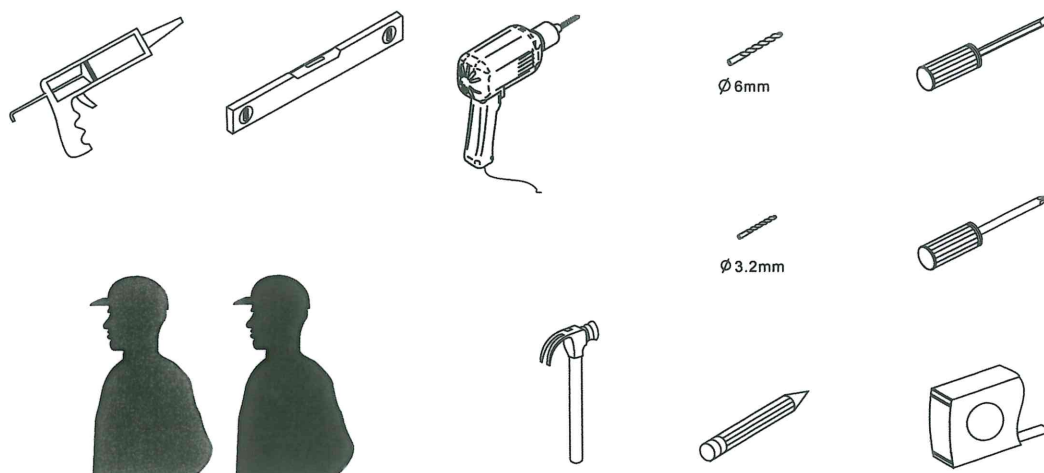













Deze producten zijn zwaar en vereisen 2 personen voor de installatie.
Les produits sont assez lourds, l'installation est avisé à faire par 2 personnes.



PACKING LIST

- INHOUD TE CONTROLEREN VOOR INSTALLATIE
- A VERIFIER AVANT INSTALLATION

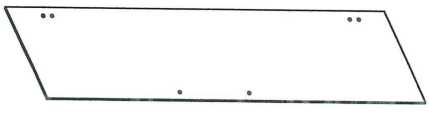
[1]	<p>2 scharnieren + 4 schroeven M5 x 35 + 4 pluggen + 4 afdekkapjes 2 charnières + 4 vis M5 x 35 + 4 chevilles + 4 caches vis</p>	➔		
[2]	<p>1 installatie-instructie 1 manuel de pose</p>	➔		
[3]	<p>1 set deurgrepen 1 set poignées</p>	➔		
[4]	<p>4 pluggen + 4 schroeven M4 x 35 4 chevilles + 4 vis M4 x 35</p>	➔		
[5]	<p>1 aluminium element + 2 clipsen + 2 schroeven Mx35 + 2 afdekkapjes schroeven 1 élément aluminium + 2 clips + 2 vis Mx35 + 2 caches vis</p>	➔		
[6]	<p>2 geleiders 2 conducteurs</p>	➔		
[7]	<p>2 magnetische elementen 2 éléments magnétiques</p>	➔		
[8]	<p>1 profiel 1 profil</p>	➔		
[9]	<p>1 deurpaneel 1 panneau de porte</p>	➔		

INSTRUCTIES VOOR INSTALLATIE

MANUEL DE POSE

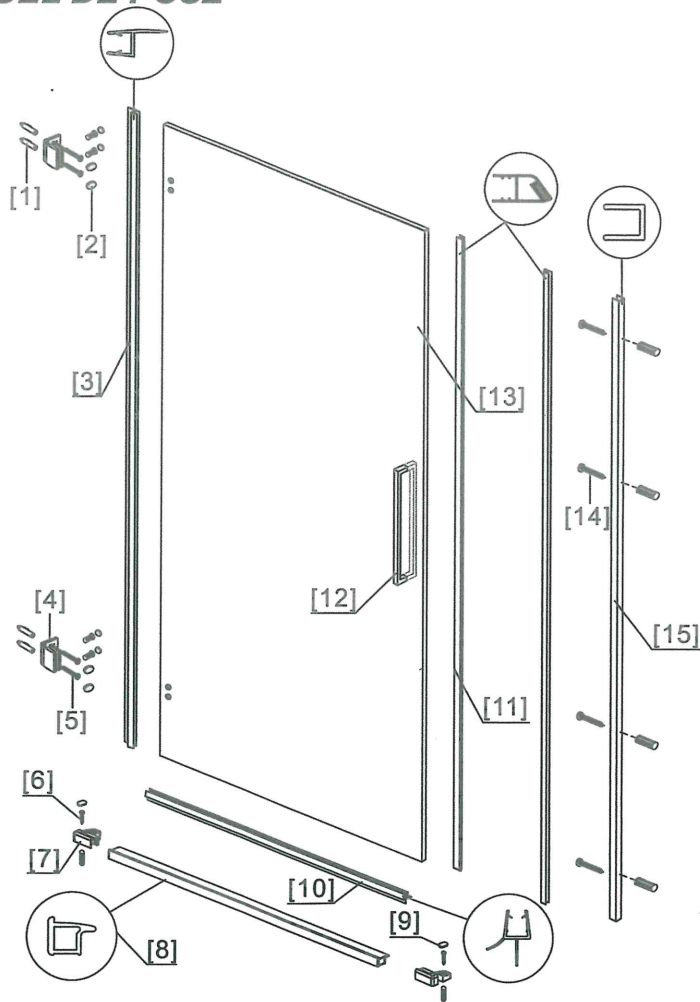

- [1] 10 pluggen
- [2] 4 afdekkapjes
- [3] 1 geleider
- [4] 2 scharnieren
- [5] 2 schroeven M5x35
- [6] 2 schroeven M4x25
- [7] 2 clipsen
- [8] 1 aluminium element
- [9] 2 afdekkapjes
- [10] 1 geleider
- [11] 2 magnetische elementen
- [12] 1 set deurgrepen
- [13] 1 deurpaneel
- [14] 4 schroeven M4x35
- [15] 1 profiel

- [1] 10 chevilles
- [2] 4 caches vis
- [3] 1 conducteur
- [4] 2 charnières
- [5] 2 vis M5x35
- [6] 2 vis M4x25
- [7] 2 clips
- [8] 1 élément aluminium
- [9] 2 caches vis
- [10] 1 conducteur
- [11] 2 éléments magnétiques
- [12] 1 set poignées
- [13] 1 panneau de porte
- [14] 4 vis M4x35
- [15] 1 profil

◆ Installation Steps

Step 1

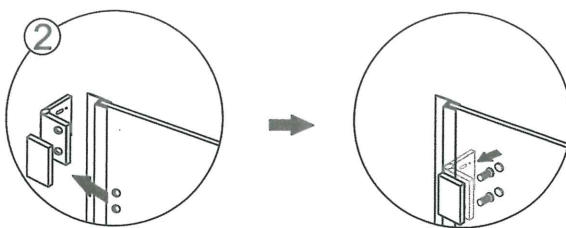
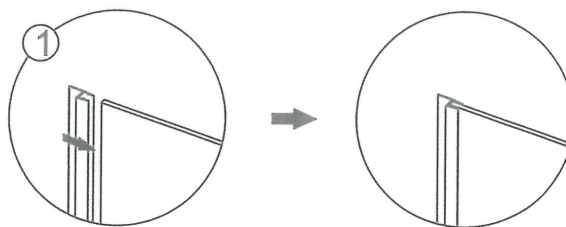
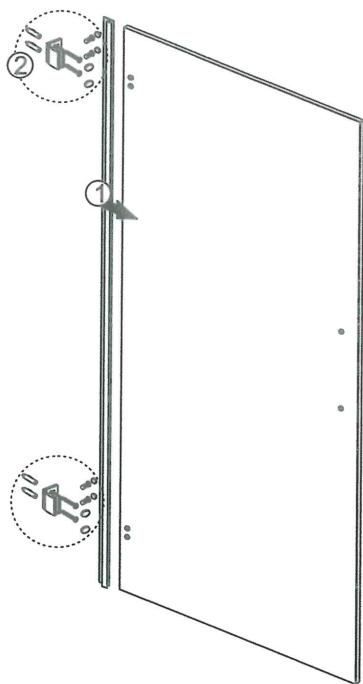

Step 2

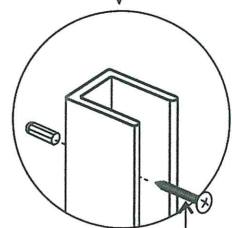
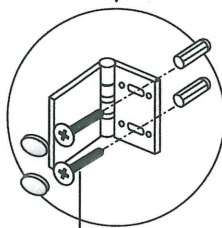
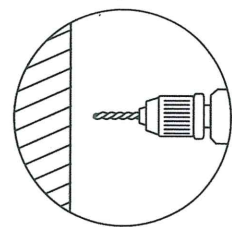
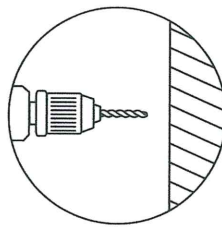
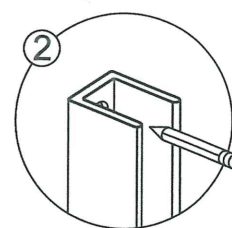
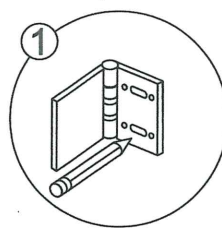
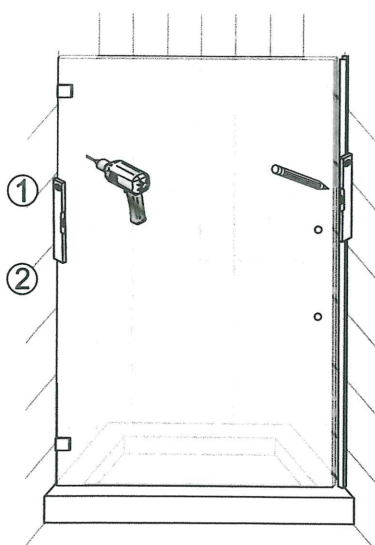

M5x35

M4x35

Step 3

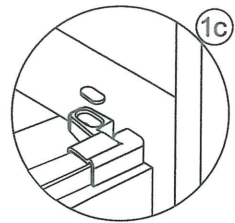
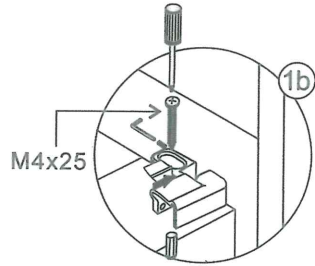
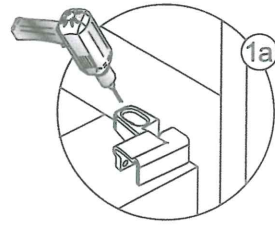
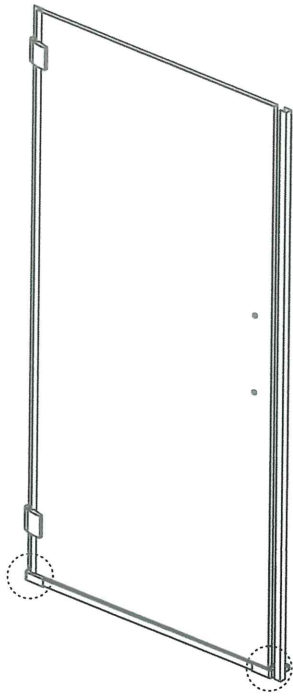

Step 4

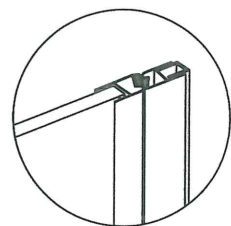
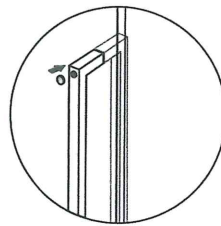
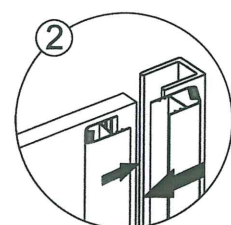
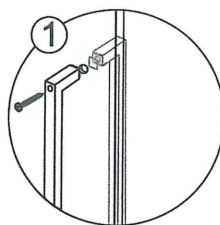
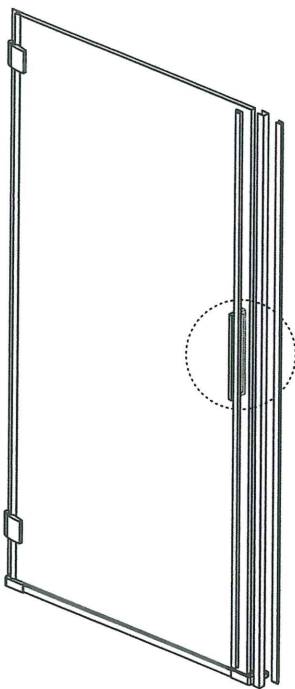

Step 5

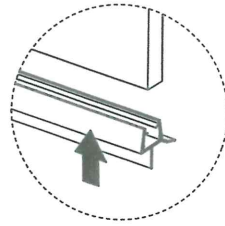
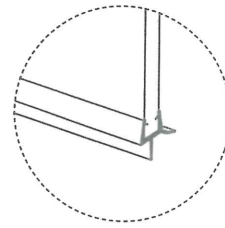
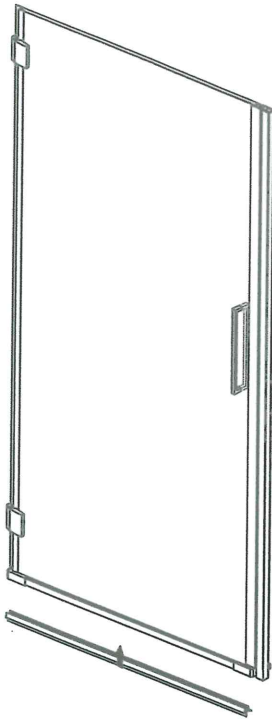

Step 6

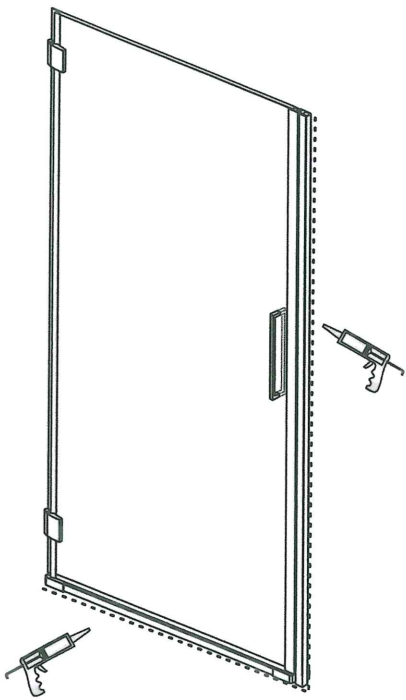

Allow 24 hours for silicone to dry before use.

DEUR PORTE	Breedte - Largeur	Hoogte - Hauteur
BHD108	780 > 800	2000
BHD109	880 > 900	2000

belsh

